

AC/DC POWER SUPPLY KIT

MODEL K-11

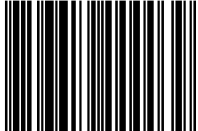

7 56619 00003 9

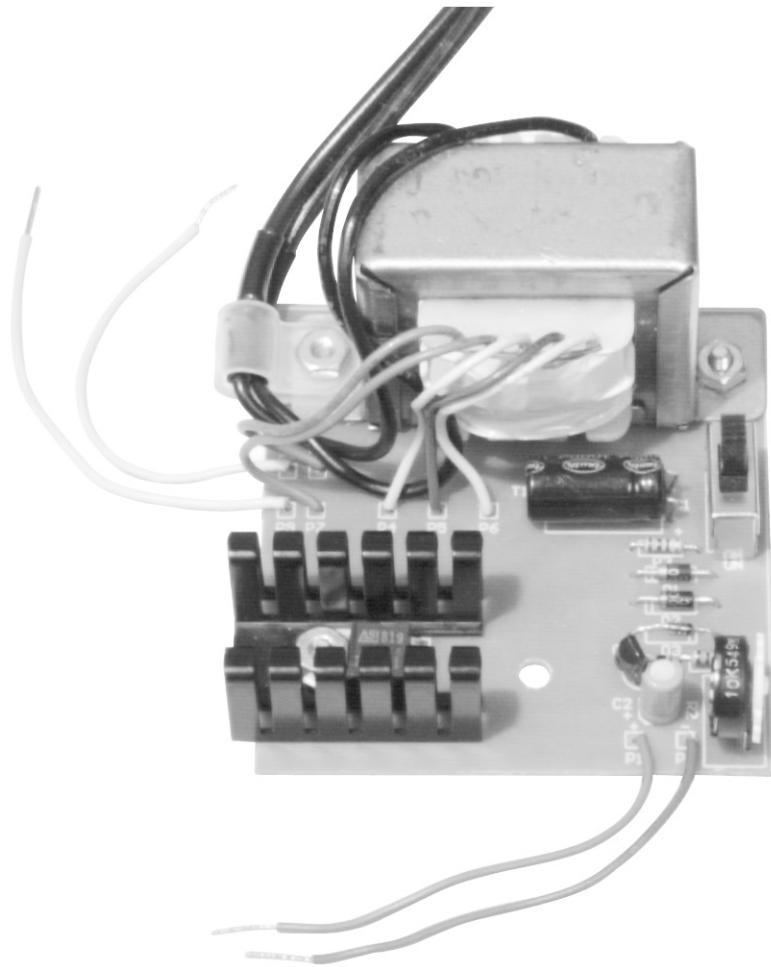

Assembly and Instruction Manual

Elenco® Electronics, Inc.

PARTS LIST

If you are a student, and any parts are missing or damaged, please see instructor or bookstore.

If you purchased this AC/DC power supply kit from a distributor, catalog, etc., please contact Elenco® Electronics (address/phone/e-mail is at the back of this manual) for additional assistance, if needed. **DO NOT** contact your place of purchase as they will not be able to help you.

RESISTORS

Qty.	Symbol	Value	Color Code	Part #
<input type="checkbox"/> 1	R1	1kΩ 5% 1/4W	brown-black-red-gold	141000
<input type="checkbox"/> 1	R3	2.7kΩ 5% 1/4W	red-violet-red-gold	142700
<input type="checkbox"/> 1	R2	10kΩ Potentiometer		191516

CAPACITORS

Qty.	Symbol	Value	Description	Part #
<input type="checkbox"/> 1	C2	100μF	Electrolytic	281045
<input type="checkbox"/> 1	C1	1000μF	Electrolytic	291045

SEMICONDUCTORS

Qty.	Symbol	Value	Description	Part #
<input type="checkbox"/> 2	D1, D2	1N4001	Diode	314001
<input type="checkbox"/> 1	D3	1N5247	Zener Diode	315247
<input type="checkbox"/> 1	Q1	2N3904	Transistor	323904
<input type="checkbox"/> 1	Q2	2N6121 / HT1061	Transistor	326121

MISCELLANEOUS

Qty.	Symbol	Description	Part #
<input type="checkbox"/> 1	T1	Transformer YD-1485.....	440111
<input type="checkbox"/> 1		PC Board.....	518011
<input type="checkbox"/> 1	S1	Slide Switch.....	541009
<input type="checkbox"/> 1		Solder Roll.....	551124
<input type="checkbox"/> 1		Heat Sink.....	615002
<input type="checkbox"/> 1		Cable Clamp 1/4".....	628750
<input type="checkbox"/> 3		Screw 6-32 x 5/16".....	641641
<input type="checkbox"/> 3		Nut 6-32.....	644600
<input type="checkbox"/> 1		Line Cord.....	862100
<input type="checkbox"/> 1		Shrink Tubing 2".....	890120

PARTS IDENTIFICATION

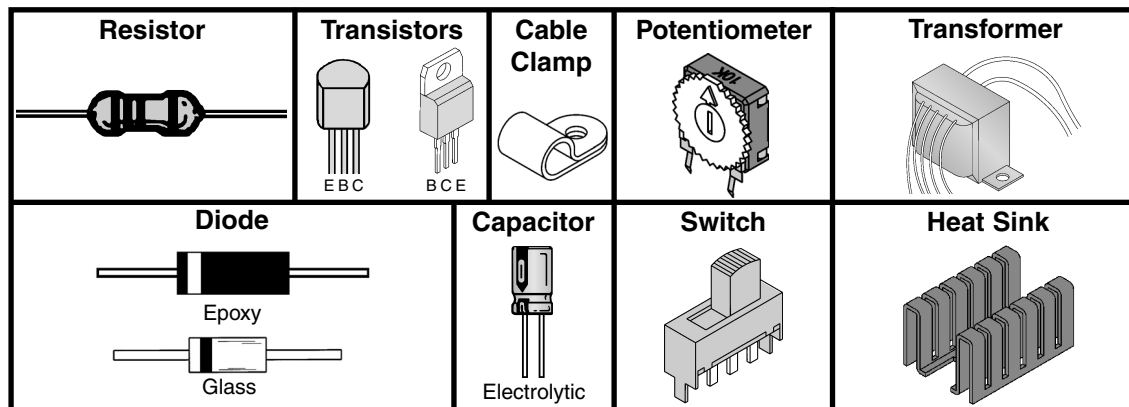

INTRODUCTION

The electrical power that is supplied by your power company is what is known as Alternating Current or AC. This current is constantly changing amplitude and polarity (see Figure 1). The electrons (current) move back and forth at a rate of 60 times per second. This type of current is not suitable for most electronic circuits. It must be converted into a Direct Current or DC which moves in one direction only. Your Multi-Purpose Power Supply does exactly that. It converts

AC into DC. It also allows you to vary the amplitude of the voltage from 0-15V (0.25A - 12Vmax). Also, your power supply has an output of 8.5VAC, 0.5A without regulation.

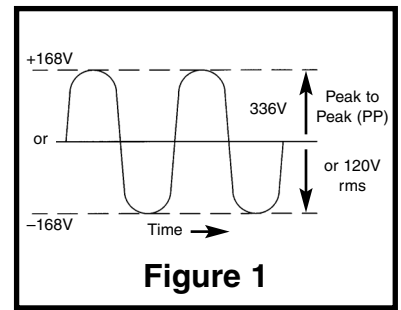

Figure 1

THEORY OF OPERATION

A block diagram of the system is shown in Figure 2. It consists of five basic circuits needed to convert 120 volts of AC to a usable 0-15 volts of DC. We will analyze each circuit for a better understanding of power supplies.

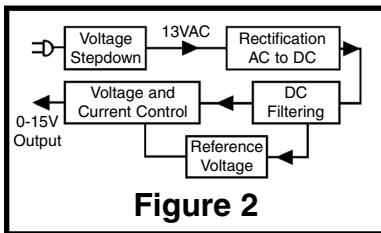

Figure 2

VOLTAGE STEP-DOWN FUNCTION

In this circuit, 120 volts of AC is reduced to two 13VAC out of phase voltages. Thirteen volts is the rms (effective) value. The peak voltage is really 18 volts. This step-down is achieved by the use of a transformer. The winding of the transformer is shown in Figure 3A and the voltage across each winding is shown in Figure 3B. In a transformer, the magnetic field produced by the 120 volts of current is induced into the secondary winding. The voltage across the secondary winding is a ratio of the number of turns between the primary and secondary winding. If the ratio was 1:1 (equal turns), then the secondary voltage would be the same as the 120 volt input. In our transformer, the ratio is 120:13. Therefore, the secondary voltage will be 13 volts. If we were to put an oscilloscope between the common lead of the two secondary windings and looked at the other leads, we would see that the two voltages are 180 degrees out of phase. This is because the windings are going in opposite directions from the common point. This is an important point in converting the AC to DC as we will see in the next section.

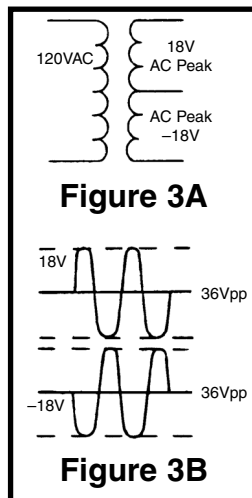

Figure 3A

Figure 3B

AC to DC CONVERSION - RECTIFICATION

This circuit that converts AC to DC consists of two diodes D1 and D2. The purpose of a diode is to pass current in only one direction (see Figure 4). If we were to take a battery and connect it to a diode and lamp, as shown in Figure 5, the lamp would only light when the diode is in the conduction direction. If we replace the battery with a transformer secondary winding, the diode will only conduct on the positive cycle of the voltage as shown in Figure 6. Note that the output of the diode is a half-wave rectification with a hole in the center. This voltage would be hard to filter out. It is desirable to fill in this area. This is done by something known as full wave rectification, which is using a second winding out of phase with the first.

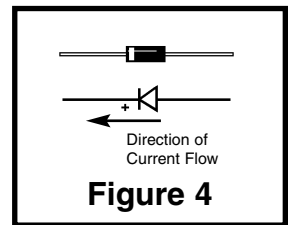

Figure 4

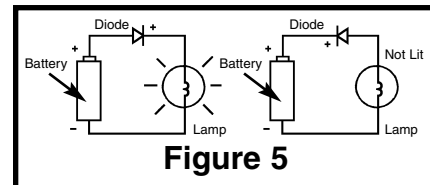

Figure 5

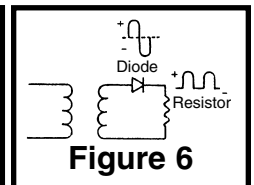

Figure 6

Figure 7A shows the circuit for a full wave rectification. Note that diode D1 conducts the previously described and diode D2, one half cycle later. The diodes conduct only when the voltage goes positive and no current flows on the negative half. The resulting output voltage waveforms are shown in Figure 7B. Note that there is no longer a gap between cycles. This will make it easier to filter the output voltage.

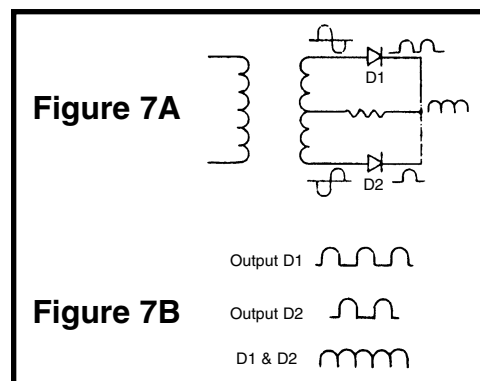
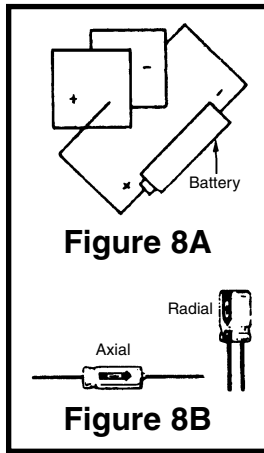

Figure 7A

Figure 7B

FILTERING

Filtering is the process of smoothing out AC hills produced by the full wave rectifiers. The circuit consists of the 1000 μ F capacitor C1. A capacitor is an electrical device that stores electrical energy. If two metal plates are placed very close to each other and are connected to a battery, a current will flow momentarily, even though there is no connection between the plates (see Figure 8A). If the battery is removed, a voltage will remain on the plates. These plates are now charged and will act like a battery. Current can be drawn from this capacitor until the charge is consumed. Typical capacitors are shown in Figure 8B.



The capability of storing a charge on a capacitor is measured in farads (F). Most capacitors used in electronic power supplies are rated in microfarads (μ F) which means one millionth of a farad. Typical values are 100 to 10,000 μ F. Capacitors used in power supplies are called electrolytics because of their design. An electrolytic is used in a power supply to smooth out the rectified AC voltages. During the peak voltage, energy is supplied to the capacitor and released during the valleys between the peaks (see Figure 9). The current through the diode will initially be very high until the electrolytic is charged. Then, little bursts of current are needed to supply the current going to the load. Remember, current will only flow through the diode when the driving voltage is greater than the DC across the electrolytic.

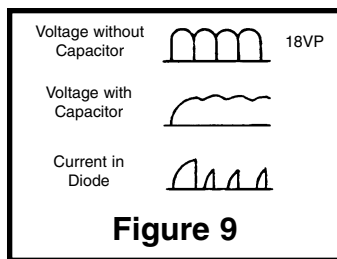

REFERENCE VOLTAGE

An important element of a well regulated power supply is a dependable reference voltage. This gives a stable voltage which does not vary with the load current. The component used to make this voltage in Elenco's™ supply is called a zener diode (D3).

In our discussion of diodes, we talked about current flow in one direction, but none when we reverse the voltage. If, in the reverse direction, we keep increasing the voltage, the diode will breakdown and current will eventually flow. This breakdown is called zener voltage. Manufacturers have learned to control this breakdown voltage and supply zener diodes for almost

any voltage. Figure 10 shows the zener circuit used in our power supply. The DC filter output voltage will vary between 18 minimum and a higher voltage, depending on load current. The voltage across the zener diode will remain constant at 17V. This constant voltage is important to control the output of the regulators as you will see in the following section.

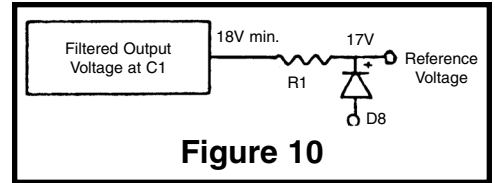

VOLTAGE REGULATOR

Figure 11A shows the circuit of the voltage regulator. It consists of two transistors and a variable resistor. Our objective is to control the output of Q1 to give the desired voltage of 0-15 volts. This output should not change with different loads.

To understand the circuit operations, we must have a little knowledge of transistors. Briefly, the voltage at the emitter (Figure 11B) of a transistor will be .7V less than the voltage on the base. If we put 10 volts on the base, then 9.3 volts will appear on the emitter. The emitter voltage will stay fixed, even though the collector voltage may vary. Thus, increasing or decreasing the collector voltage will not effect the emitter voltage, providing the base voltage stays fixed. If we increase the load on the transistor, more current will flow. This increased current will produce a drop in the filter DC voltage across the electrolytic, but the zener diode will hold the reference fixed and thus the output voltage of Q1 will be constant. This process is called Regulation. A good regulator will not change the output voltage with load current changes.

To vary the output voltage of transistor Q1, we place a variable resistor R2 to divide the output from the zener diode. Thus, we can vary the 17 volt zener output between 0-17 volts and control Q1's output. Transistor Q2 is used to reduce the current drawn from the zener circuit.

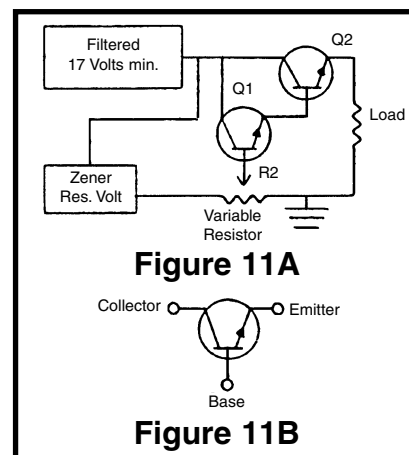

CONSTRUCTION

Introduction

The most important factor in assembling your K-11 Power Supply Kit is good soldering techniques. Using the proper soldering iron is of prime importance. A small pencil type soldering iron of 25 - 40 watts is recommended. **The tip of the iron must be kept clean at all times and well tinned.**

Solder

For many years leaded solder was the most common type of solder used by the electronics industry, but it is now being replaced by lead-free solder for health reasons. This kit contains lead-free solder, which contains 99.3% tin, 0.7% copper, and has a rosin-flux core.

Lead-free solder is different from lead solder: It has a higher melting point than lead solder, so you need higher temperature for the solder to flow properly. Recommended tip temperature is approximately 700°F; higher temperatures improve solder flow but accelerate tip decay. An increase in soldering time may be required to achieve good results. Soldering iron tips wear out faster since lead-free solders are more corrosive and the higher soldering temperatures accelerate corrosion, so proper tip care is important. The solder joint finish will look slightly duller with lead-free solders.

Use these procedures to increase the life of your soldering iron tip when using lead-free solder:

- Keep the iron tinned at all times.
- Use the correct tip size for best heat transfer. The conical tip is the most commonly used.

- Turn off iron when not in use or reduce temperature setting when using a soldering station.
- Tips should be cleaned frequently to remove oxidation before it becomes impossible to remove. Use Dry Tip Cleaner (Elenco® #SH-1025) or Tip Cleaner (Elenco® #TTC1). If you use a sponge to clean your tip, then use distilled water (tap water has impurities that accelerate corrosion).

Safety Procedures

- **Always wear safety glasses or safety goggles to protect your eyes when working with tools or soldering iron, and during all phases of testing.** 
- Be sure there is **adequate ventilation** when soldering.
- Locate soldering iron in an area where you do not have to go around it or reach over it. Keep it in a safe area away from the reach of children.
- **Do not hold solder in your mouth.** Solder is a toxic substance. Wash hands thoroughly after handling solder.

Assemble Components

In all of the following assembly steps, the components must be installed on the top side of the PC board unless otherwise indicated. The top legend shows where each component goes. The leads pass through the corresponding holes in the board and are soldered on the foil side.

Use only rosin core solder.

DO NOT USE ACID CORE SOLDER!

What Good Soldering Looks Like

A good solder connection should be bright, shiny, smooth, and uniformly flowed over all surfaces.

1. Solder all components from the copper foil side only. Push the soldering iron tip against both the lead and the circuit board foil.

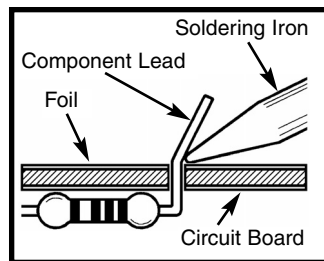

2. Apply a small amount of solder to the iron tip. This allows the heat to leave the iron and onto the foil. Immediately apply solder to the opposite side of the connection, away from the iron. Allow the heated component and the circuit foil to melt the solder.

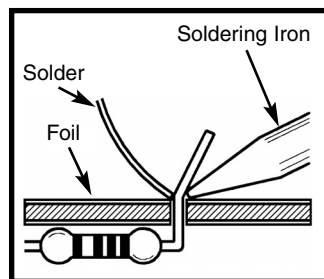

3. Allow the solder to flow around the connection. Then, remove the solder and the iron and let the connection cool. The solder should have flowed smoothly and not lump around the wire lead.

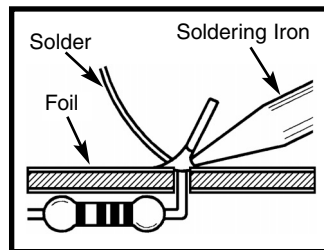

4. Here is what a good solder connection looks like.

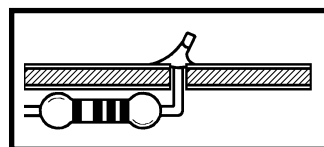

Types of Poor Soldering Connections

1. **Insufficient heat** - the solder will not flow onto the lead as shown.

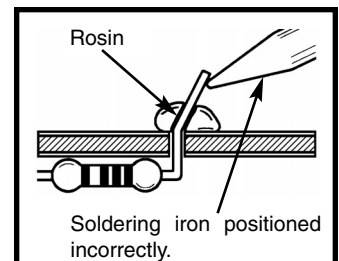

2. **Insufficient solder** - let the solder flow over the connection until it is covered. Use just enough solder to cover the connection.

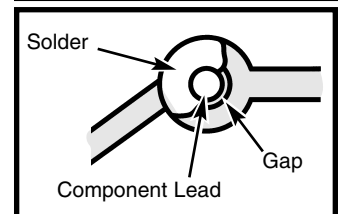

3. **Excessive solder** - could make connections that you did not intend to between adjacent foil areas or terminals.

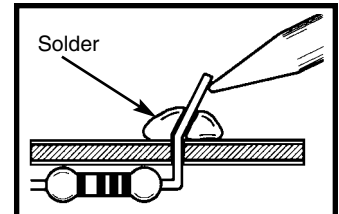

4. **Solder bridges** - occur when solder runs between circuit paths and creates a short circuit. This is usually caused by using too much solder. To correct this, simply drag your soldering iron across the solder bridge as shown.

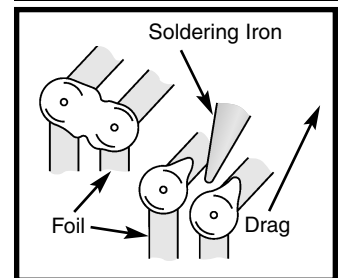

ASSEMBLE COMPONENTS TO THE PC BOARD

- T1 - Transformer, two 6-32 x 5/16" Screws, two 6-32 Nuts, Shrink Tubing, Cable Clamp, & Line Cord

- Cut the shrink tubing into two 1" sections. Slip a section of tubing onto each of the two lead wires on the line cord.
- Twist each of the two wires on the line cord with the two black wires from the transformer. Solder these wires.
- Slide the shrink tubing down over both black wires to cover the solder joints. Doing this will prevent a shock hazard.
- Keeping your soldering iron close, but not touching, let the heat from the iron shrink the tubing.
- Using two screws, two nuts and a cable clamp, install the transformer onto the PC board.
- Cut a 3" section off of each of the red, yellow, and blue transformer leads. They will be used later. Strip 1/4" off of the leads.
- Solder the two yellow, two red and one blue lead from the transformer to the pads of the PC board as shown.

- P8 - 3" yellow wire *

- P9 - 3" yellow wire *

- Q2 - 2N6121/HT1061 Transistor
Heat Sink
6-32 x 5/16" Screw
6-32 Nut
(see Figure A)

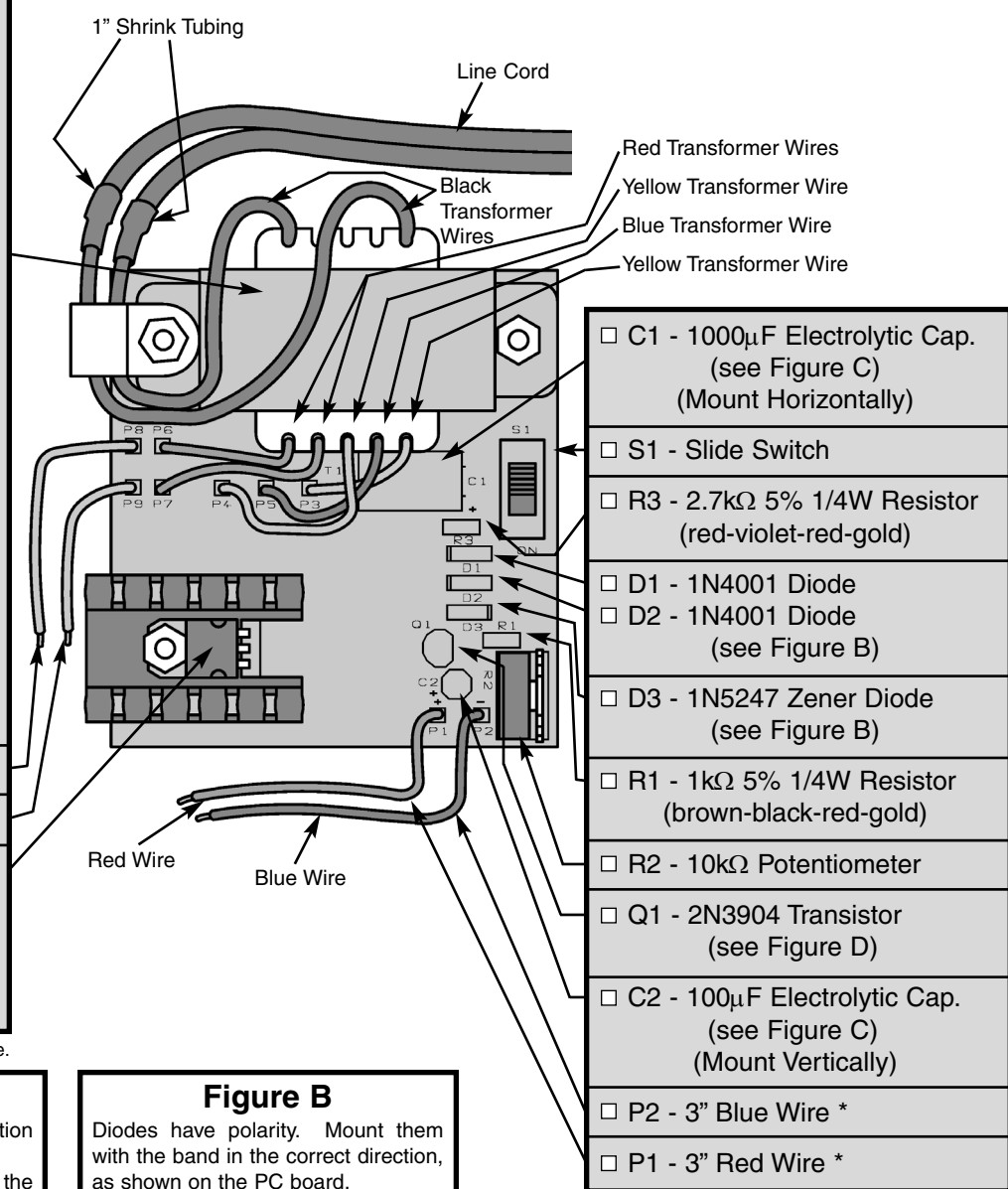

- C1 - 1000µF Electrolytic Cap. (see Figure C) (Mount Horizontally)
- S1 - Slide Switch
- R3 - 2.7kΩ 5% 1/4W Resistor (red-violet-red-gold)
- D1 - 1N4001 Diode
- D2 - 1N4001 Diode (see Figure B)
- D3 - 1N5247 Zener Diode (see Figure B)
- R1 - 1kΩ 5% 1/4W Resistor (brown-black-red-gold)
- R2 - 10kΩ Potentiometer
- Q1 - 2N3904 Transistor (see Figure D)
- C2 - 100µF Electrolytic Cap. (see Figure C) (Mount Vertically)
- P2 - 3" Blue Wire *
- P1 - 3" Red Wire *

* Strip 1/4" of insulation off of both ends of the wire.

Figure A

Bend the leads of the transistor in the direction shown below. Install the transistor with the heat sink onto the component side of the PC board using the screw and nut as shown. Solder the leads of the transistor and cut off the excess leads.

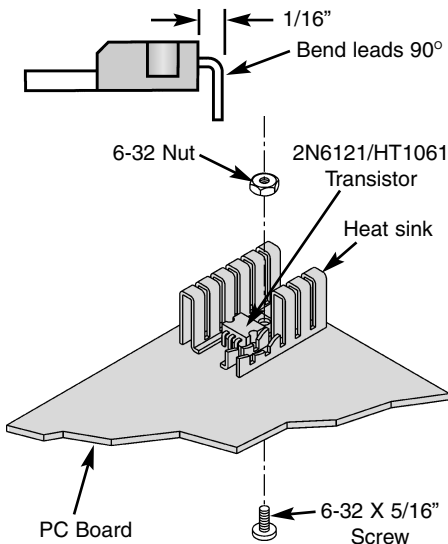

Figure B

Diodes have polarity. Mount them with the band in the correct direction, as shown on the PC board.

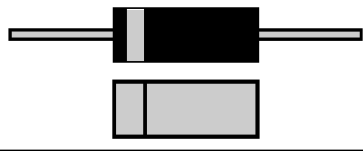

Figure C

Electrolytic capacitors have polarity. Be sure to mount them with the negative (-) lead (marked on side) in the correct hole. Bend the capacitor as shown.

Warning:

If the capacitor is connected with incorrect polarity, it may heat up and either leak, or cause the capacitor to explode.

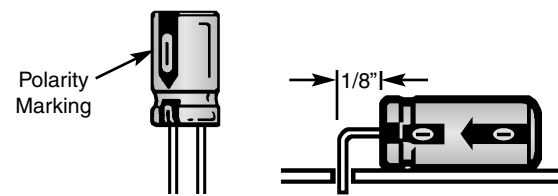
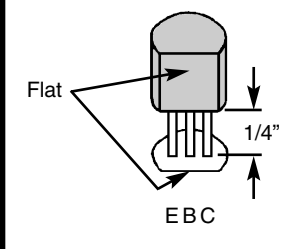

Figure D

Mount the transistor with the flat side in the same direction as shown on the PC board. Solder and cut off the excess leads.



OPERATING PROCEDURE

To operate the K-11 Power Supply, plug the line cord into a 120V, 60Hz AC outlet, turn the switch (S1) to the ON position and rotate the potentiometer (R2) to make the output voltage climb from 0 to 15 volts DC. The red wire from P1 is the positive output, the blue wire from P2 is the negative DC output, and the two yellow wires are the AC output - 8.5V without regulation.

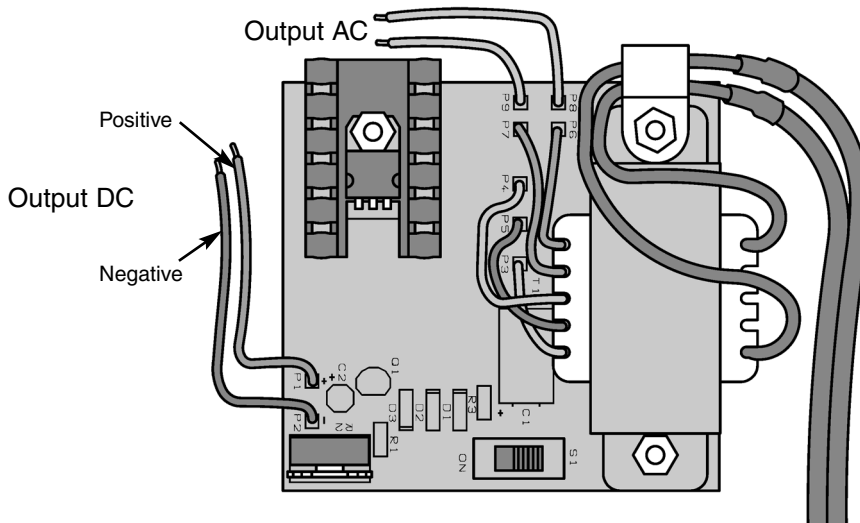

OUTPUT

DC: 0-15V @ 250mA

AC: 8.5V @ 500mA

TROUBLESHOOTING

One of the most frequently occurring problems is poor solder connections.

1. Tug slightly on all parts to make sure that they are indeed soldered.
2. All solder connections should be shiny. Resolder any that are not.
3. Solder should flow into a smooth puddle rather than a round ball. Resolder any connection that has formed into a ball.
4. Have any solder bridges formed? A solder bridge may occur if you accidentally touch an adjacent foil by using too much solder or by dragging the soldering iron across adjacent foils. Break the bridge with your soldering iron.

COMPONENT CHECK

1. Be sure that all components have been mounted in their correct places.
2. Be sure that the electrolytic capacitors C1 and C2 have been installed correctly. These capacitors have polarity, the negative and positive leads must be in the correct holes.
3. Be sure that diodes D1 - D3 have not been installed backwards. The band on the diodes should be in the same direction as shown in the pictorial diagram.

SCHEMATIC DIAGRAM

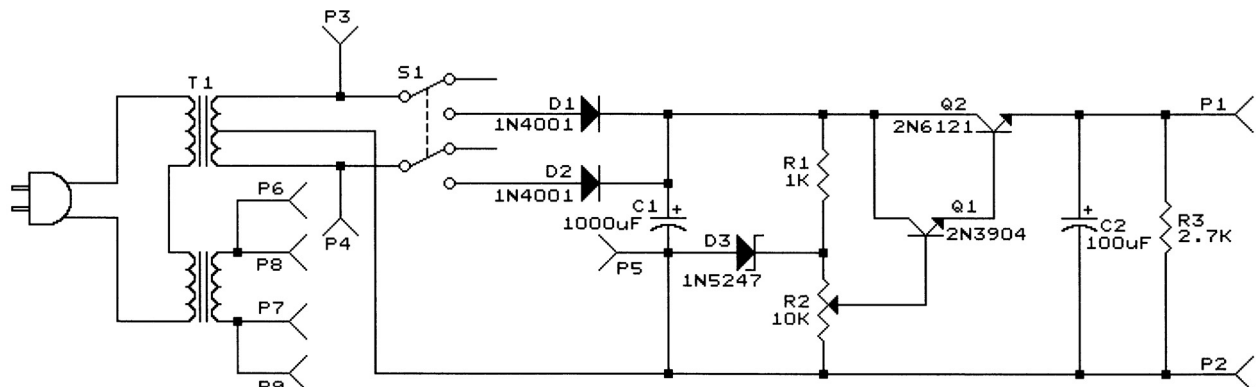

QUIZ

Mark the box next to the letter with the correct answer.

1. AC voltage is supplied to the rectifier stages by the . . .
 - A. step-up transformer.
 - B. step-down transformer.
 - C. 1-to-1 transformer.
 - D. AC-to-DC transformer.
2. The secondary windings of the transformer are . . .
 - A. 90° out of phase.
 - B. 180° out of phase.
 - C. 270° out of phase.
 - D. 320° out of phase.
3. Diodes allow current to flow . . .
 - A. when the anode is more negative than the cathode.
 - B. when the cathode is more positive than the anode.
 - C. in one direction.
 - D. when a negative or positive voltage is on the anode.
4. What circuit is more efficient for rectifying AC to DC?
 - A. Hartley oscillator.
 - B. Half-wave.
 - C. Schmitt trigger.
 - D. Full-wave.
5. The DC voltage is filtered by using a . . .
 - A. half-wave rectification circuit.
 - B. small value capacitor with a high voltage value.
 - C. Large value capacitor.
 - D. 90° out of phase rectification circuit.
6. An inefficient rectification circuit usually contains . . .
 - A. large gaps between cycles.
 - B. twice the AC voltage needed.
 - C. more diodes.
 - D. all of the above.
7. The ratio of the transformer in the K11 is . . .
 - A. 50:1.
 - B. 1:10.
 - C. 120:13.
 - D. 60:120.
8. The voltage at the emitter of a transistor is . . .
 - A. 0.7 volts less than the base.
 - B. 2 volts higher than the collector.
 - C. same as the collector.
 - D. 1.25 volts lower than the base.
9. A good regulator circuit . . .
 - A. changes the output under load.
 - B. contains many transistors.
 - C. will not change under load.
 - D. uses small capacitors.
10. Transistor Q2 is used to . . .
 - A. rectify the AC voltage.
 - B. filter the DC voltage.
 - C. amplify the AC voltage.
 - D. reduce the current draw from the zener.

Elenco® Electronics, Inc.

150 Carpenter Avenue
Wheeling, IL 60090
(847) 541-3800

Website: www.elenco.com

e-mail: elenco@elenco.com